

Technische Daten:
Hygieneschutzfuß - 167

Datasheet:
Hygiene/Sneeze guard post - 167

Art. 20.1670.000.20

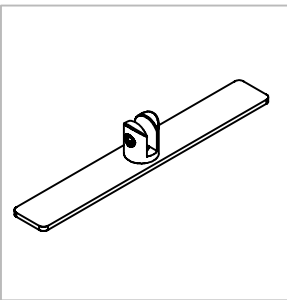

Ausführung:
Options:

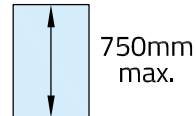
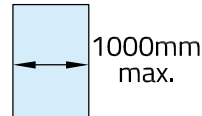
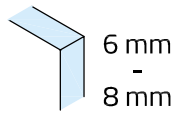

Material: V2A
Material: Stainless steel AISI 304

Gewicht: / Weight: 0,340 kg

Oberflächen: Edelstahl-Design
Finish: Stainless steel design

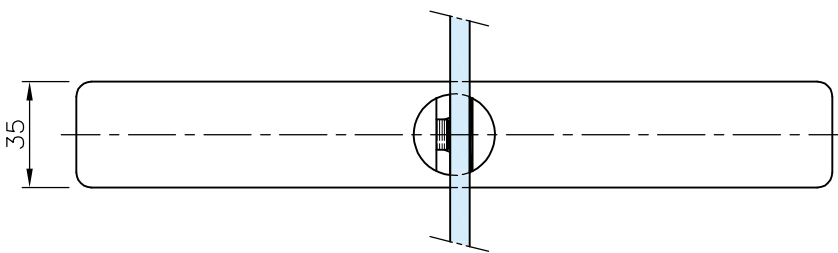
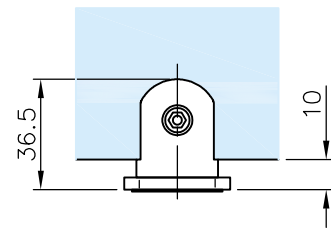
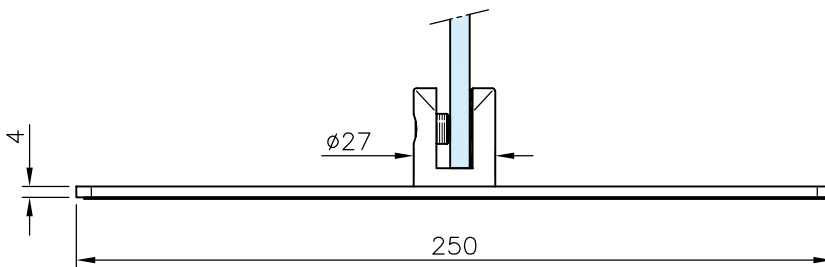

Velour Auflagen zum Oberflächenschutz
Velour pads for surface protection

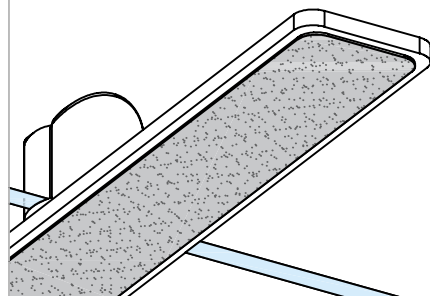

Montage:
Installation:

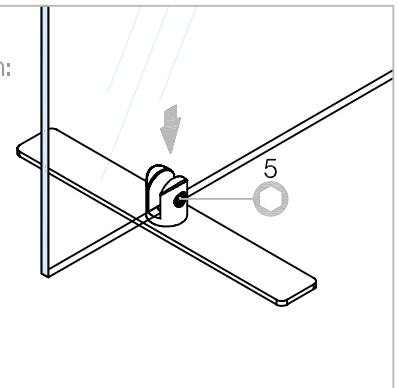

G-FITTINGS GmbH

Marie-Curie-Straße 16-18
46446 Emmerich am Rhein
T +49 (0)2822 962 0
F +49 (0)2822 962 221
E sales@g-fittings.com